

www.inventelevator.com



Office Address :
1901, 19th Floor, Parklane Tower,
Business Bay, Dubai

Phone :
+971 4 575 3622
+971 52 267 2800
+971 52 375 3356

Email :
info@inventelevator.com

Website :
www.inventelevator.com

Head Office :
Steelmould Sharjah,
Industrial Area 02,
Sharjah,
UAE PO Box 7109



[Better Products, Better Solutions.]





ELEVATOR INDUSTRY BEST IN CLASS PRODUCTS & SOLUTION

Establishment Invent Elevator was founded in 2022 by Mr. Rakesh Jethi (Founder & Director).

It was envisioned with a sound technical legacy for engineering, designing and manufacturing the latest world-class elevator equipment, with a commitment to provide the best innovative global products. Work Culture is synonymous with innovation and engineering excellence. We identify potential innovations early on by continuously analyzing the opportunities. We translate the results into immediate measures to match the necessary requirements at personnel, technical and organizational levels.

At Invent Elevator, customer satisfaction is one of the performance drivers at the organization level. Consequently, we focus on personal visits, attendance at trade fairs / exhibitions and our internet presence facilitate excellent communication with our national & international customers. Good management practices have helped us to diligently adhere to delivery schedules, with prompt and attentive after sales services. Well researched and accepted technical innovations are instantly incorporated before they become apparent. Our professional and sincere approach coupled with reliable inventiveness puts to test the best of our competitors. Feasibility studies and technological development is backed by the latest global infrastructure comprising of precision machinery and tools. This enables us to offer a truly worldclass progressive work environment.



At Invent Elevator, we are bold enough to define our place in the business world. We remain in sync with the present modern times. Freedom of speech among employees inspires ideas and innovative skills and nurtures excellence. This enables us to dare and dream big towards our organizational goals and vision. Our Commitment & Aspirations The company's motto is Customer First. At Invent Elevator, we put the customer at the center of organizational decision-making. his earnest philosophy has enabled us to design the best, secured and comfortable elevators and ensure the paramount aspect of total safety. At Invent Elevator, we believe that Excellence is not a one-time achievement, it's a habit. We are committed to our pursuit of excellence. A commitment that does not rest of consistency, but on bettering our performance and building on our customer relationships.

At Invent Elevator, we believe in the tradition of offering a trustworthy customer experience. A diverse execution of the highest standards of service and solutions ensures a lifetime of satisfaction and quality at its best. For our employees, excellent customer service leads to the path of increased productivity, a stress-free open work environment and greater job satisfaction.

What Makes Us Credible



VISION + PERSISTENCE =
SUCCESS



Better begins here,
when business works better,
the world works better.

Inspirations

Inspiring trust and confidence. Without trust, business cannot function effectively. At Invent Elevator, we believe it is critical to build confidence both internally and with our customers, thereby creating sustainable and long-lasting relationships with your employees and customers, Empowering talent and leadership. Top talent is essential to business growth; therefore, it is mandatory for sourcing talent globally for global solutions. At Invent Elevator, we empower the right talent and ensure they grow with us, contributing to our overall success as a business.

Let your Imagination and Aspirations
take a flight. -'Explore New Avenues
with us.

Building the next generation products with high-end applications & induction
of ultra modern techniques.



**REDEFINE
THE HIGHEST
STANDARD
OF SAFETY**

Company Overview



Invent elevator is recognized as one of the leading and accomplished elevator companies in the market today. We have extensive experience in the elevator industry, in installation, managing and supervision.

Since its establishment of the company, we have strived to compete with the best in the world.

Invent elevator has swiftly climbed to greater heights and in very short span Invent Elevator has become a trusted elevator brand in Dubai. Our products are a result of in-house research and development, offering a perfect balance between state-of-the-art technology and affordability.



Vision & Mission



Our Promise



Our Inspiration

Economy Cabin

CAB-E01



Rear Wall	SS Hairline + Center Panel SS Mirror
Side Walls	SS Hairline + Center Panel SS Mirror
Skirting	SS Hairline
Suspended Ceiling	SS Hairline with Spot Lights

CAB-E02

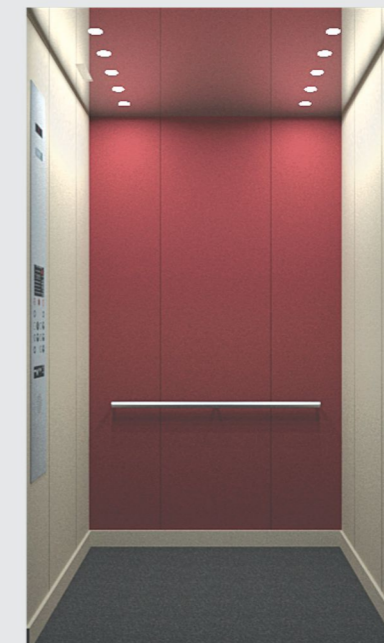

Rear Wall	PO Red
Side Walls	Oyster White
Skirting	Oyster White
Suspended Ceiling	SS Mirror with Spot Light

CAB-E03



Rear Wall	Sky Blue (RAL-5015)
Side Walls	Oyster White
Skirting	Oyster White
Suspended Ceiling	SS Mirror with Spot Light

A WIDE CHOICE OF DURABLE INTERIOR MATERIAL

Modern Cabin

CAB-M01

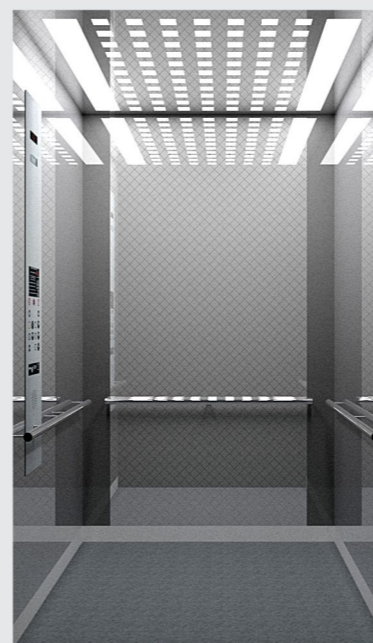

Rear Wall	Center Panel Etching + S.S. Mirror
Side Walls	S.S. Mirror
Skirting	S.S. Hairline
Suspended Ceiling	S.S. Mirror with Laser Cut

CAB-M02



Rear Wall	Center Panel Glass Mirror + SS Hairline + LED Strip Light
Side Walls	SS Hairline
Skirting	SS Hairline
Suspended Ceiling	SS Hairline with LED Strip Light

CAB-M03



Center Panels	White Back Painted Glass + SS Bronze Mirror Inlays
Corner Panels	SS Bronze Mirror
Skirting	SS Bronze Mirror
Suspended Ceiling	SS Mirror with LED Spot Light

PERFORMANCE
SAFETY
AESTHETICS
ACCESSIBILITY
REGULATIONS

Premium Cabin



A GREAT LOOK
ALWAYS COMES
IN STYLE
CAR INTERIOR
STYLE SETS

CAB-P01



Center Panels Black Pre Coated Design

Corner Panels SS Black Mirror

Skirting SS Mirror

Suspended Ceiling SS Mirror with LED Spot Light

CAB-P02



Rear Wall SS Nickel Hairline

Side Walls SS Nickel Hairline

Skirting SS Nickel Mirror

Suspended Ceiling SS Nickel Hairline with LED Spot Light

CAB-P03

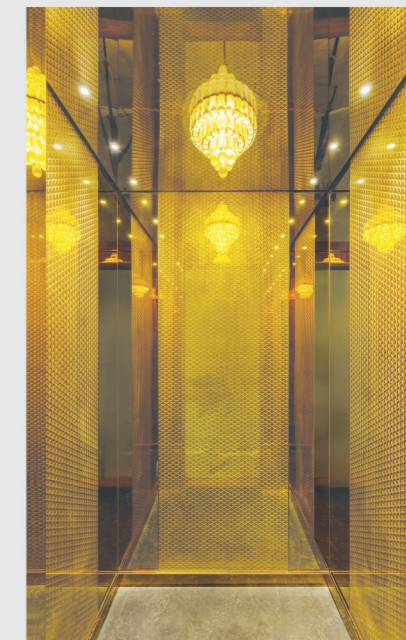

Center Panels SS Gold Etching

Corner Panels SS Gold Mirror

Skirting SS Gold Mirror

Suspended Ceiling SS Gold Mirror with LED Spot Light with Chandelier

Interior Design Cabin

DESIGNS LINES,
COLORS AND
MATERIAL
DESIGN THAT
SPEAKS TO
YOUR SENSES.

CAB-ID01



- Rear Wall** Ivory Laminate with Grooving + Flute Wooden Panel
- Left Wall** Ivory Laminate with Grooving
- Right Wall** Flute Wooden Panel
- Suspended Ceiling** SS Mirror with LED spotlights
- Flooring** Black Granite

CAB-ID02

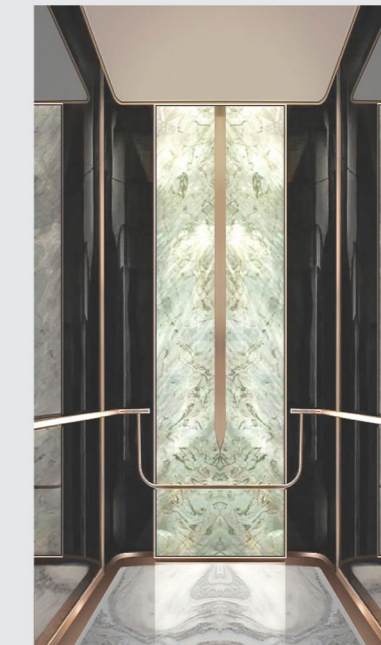

- Rear Wall** Center panel Artificial Onyx, Corners Black Mirror
- Side Walls** Center natural mirror with rose gold hairline
- Suspended Ceiling** Ivory with rose gold border
- Skirting** Rose Gold

CAB-ID03

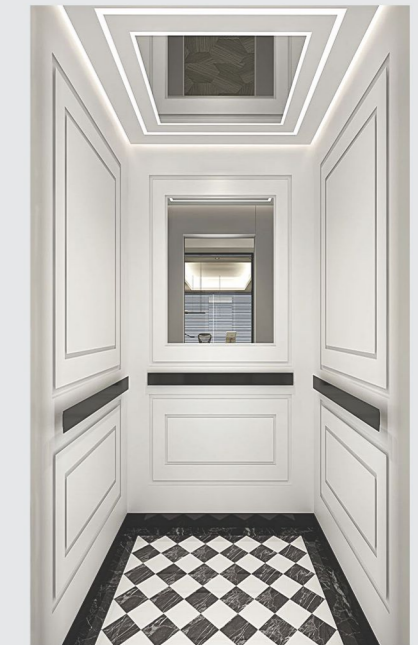

- Rear Wall** White Laminate with Grey Molding and Natural Mirror
- Side Walls** White Laminate with Grey Molding
- Suspended Ceiling** White Powder Coated with Mirror and LED Strips
- Flooring** Black Checks with Black Mirror Skirting

ENJOY
THE
VIEW



▶ Panoramic Cabin

SMOOTH OPERATION
COMFORTABLE TRAVEL

We put a great deal of thought into the sophisticated modern design and created beautiful interior styles.

The elevator offers a professional look, allow yourself a little vanity.



Single Side Glass Cabin



Two Side Glass Cabin



Three Side Glass Cabin



Five Side Glass Cabin



PARTS OF
ELEVATORS AND
IT'S FUNCTION

Door System

Fermator
AUTOMATIC DOORS FOR LIFTS



- Key Features :**
- Easy to Install.
 - Center and Side Opening.
 - Opening 600mm to 1200mm easily available.
 - Door Panels up to 2400mm height.
 - Regular, Small Vision and Big Vision easily available.

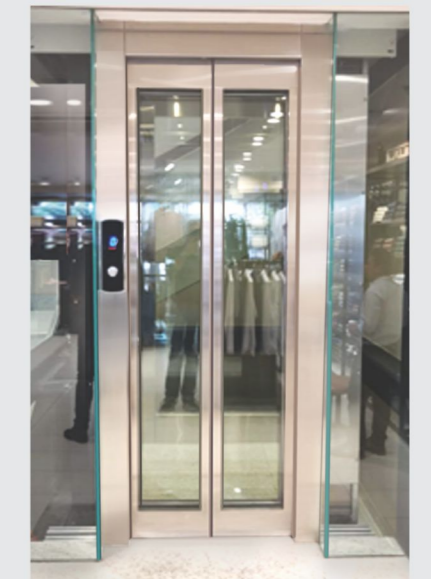
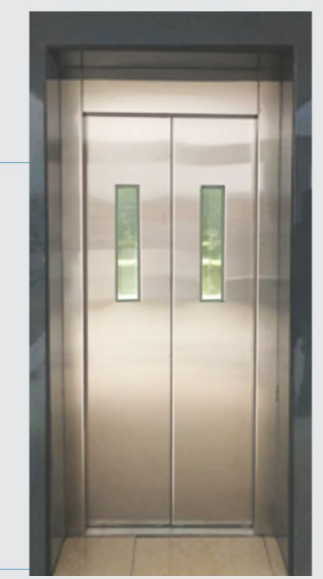

Door System



Key Features :

- Complying to latest lift directive EN81-20/50
- Complies to Fire certification EN 81-58 E120.
- Door panels are Patented to EN81-20/50
- Faster Installation, Reliability, Easy Maintenance



Product Parameters & Range

Door Type	C2	CO mm	700	800	900	1000
Sill Depth	40mm					
Side Frame Dim.	50mm x 40mm					
Top Frame Dim.	50mm					
Options	Grout Guard	CH mm	2000-2100			
Sill Load	400 Kg					
Lift Speed	up to 2.5 m/s					

• CO = Clear Opening • CH = Clear Height

Door System

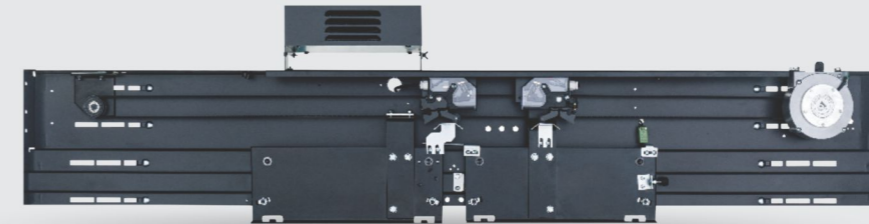

TKP131 - A09

Center Opening PM Door Operator

- The interlock has passed 1 million life cycle test, CE certified the landing door has passed 45kg pendulum impact test.
- Using self-weight door-closing mode, the self-weight and guide rod are placed in the inner side of door panel, for glass panel, the weight drop is beside the door panel.
- Delocking on door panel and door frame are available
- The interlock contact voltage: AC 110V, DC 220V
- Applicable for glass door panel

JJ	600	650	700	750	800	850	900	950	1000	1050	1100	1150	1200	1250	1300
A1	1240	1340	1440	1540	1640	1740	1840	1940	2040	2140	2240	2340	2440	2540	2640

- Using PM motor, large rotary torque, high efficiency and energy saving, compact design Highly smooth operation, achieve the completely closed loop control of the torque, speed and position Using magnetic encoder.
- Using zinc plate integrally formed guide rail, more compact design.
- Using asyn. door clutch, optional car door lock, front wall installation.
- Total door panel weight ≤ 160kg; Voltage: 200-250 V, 50 /60 Hz.

TKP161 - 05G05 Center Opening Landing Door Device



JJ	700	750	800	850	900	950	1000	1050	1100	1200
A1	1460	1560	1660	1760	1860	1960	2060	2160	2260	2460



SMOOTH
AND
COMFORT

Automatic Door



Half Vision Glass Door



Big Vision Glass Door



Full Vision Glass Door



S.S. Center Opening
Autodoor



S.S. Telescopic
Autodoor



S.S. Small Vision
Center Opening Autodoor

RIGOROUSLY
TESTED FOR
FULL PROOF
PERFORMANCE

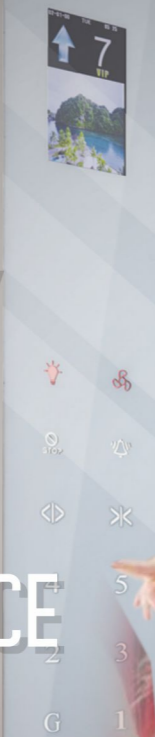

Surface Mounted

COP-LOP SERIES



HCP/317

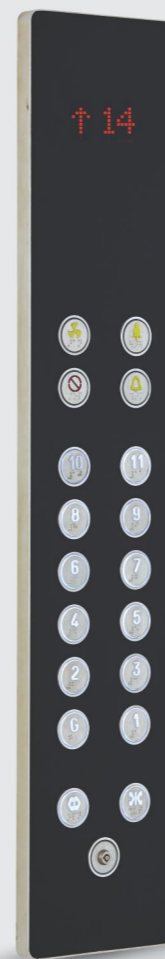

HLP/317



HCP/315



HLP/315



HCP/316

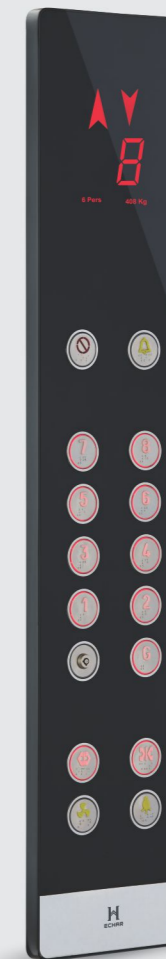

HLP/316 DLX



HLP/316



Surface Mounted

COP-LOP SERIES

CSM/301



CSM/302



P101



LSM/102



CSM/301 DLX



LSM/302



LSM/301



Surface Mounted

COP-LOP SERIES

Same Face Plate Panel can be made available in Box Type

(Ultra-Thin Design)

HCP/405



HCP/406



HLP/405 DLX



HLP/405



HLP/406



HCP/501



HLP/501 DLX



Ultra - Thin Design

14 MM



SLIM BUTTON



Box Type

COP-LOP SERIES



Emergency Alarm



Fire Man Switch



Hall Lantern

HCHB/990



HLP/990



HCFB/981

HLP/981 DLX



Touch Type

COP-LOP SERIES

Face Plate is made from toughened glass

TCB/809



TLB/809



TCW/810



TLW/810

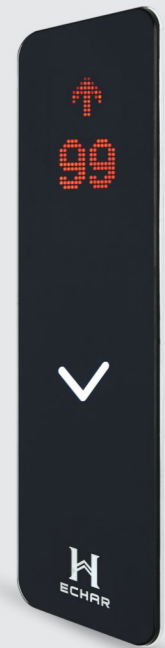



**SLIM
BUTTON**

Push Button



EEF 1089



EEF 1809



EEF 1035



EEF 1305



HRL 1014



HRL 1011M



HRL 1008



HRL 3201



HRL 1009



HRL 1007



HRL 1017



HRL 11

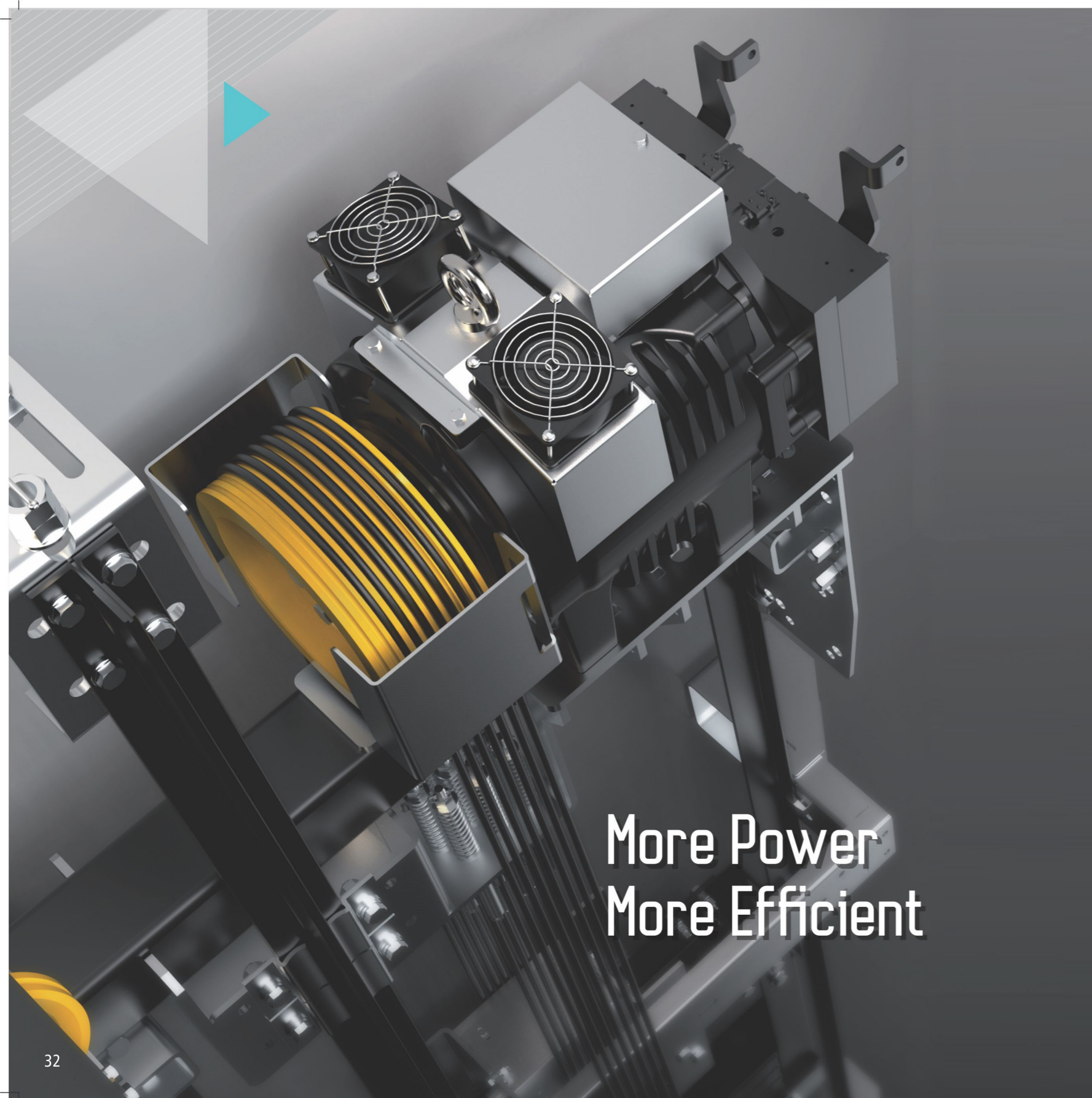

More Power
More Efficient

Elevator Machine



Montanari Giulio & C.

Gearless Machine Unit

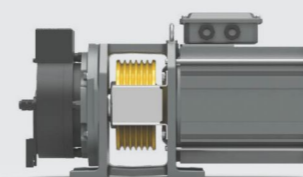

MGI 17
Traction Machine

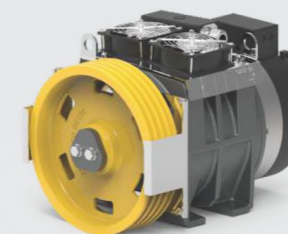

MGI 27S
Traction Machine

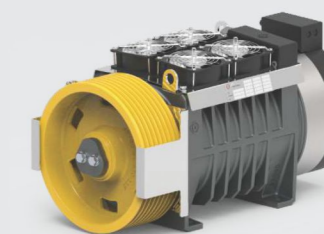

MGI 27 ML
Traction Machine

Geared Machine Unit

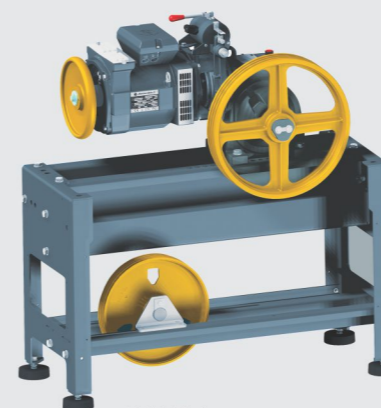

M 77
Traction Machine

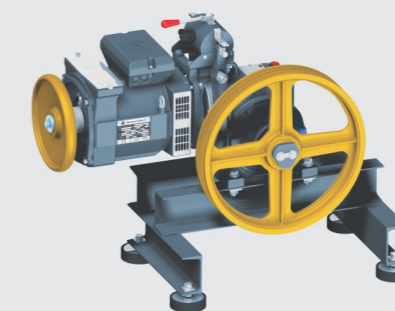

M 67
Traction Machine

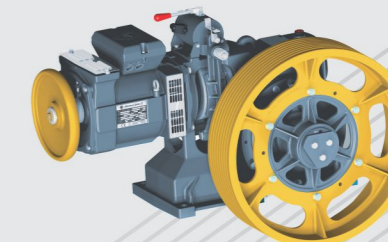

M 93
Traction Machine

Components

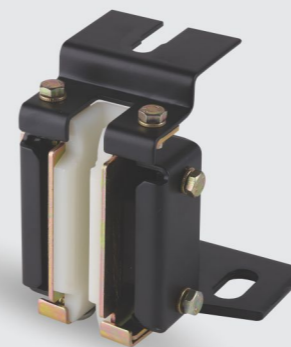
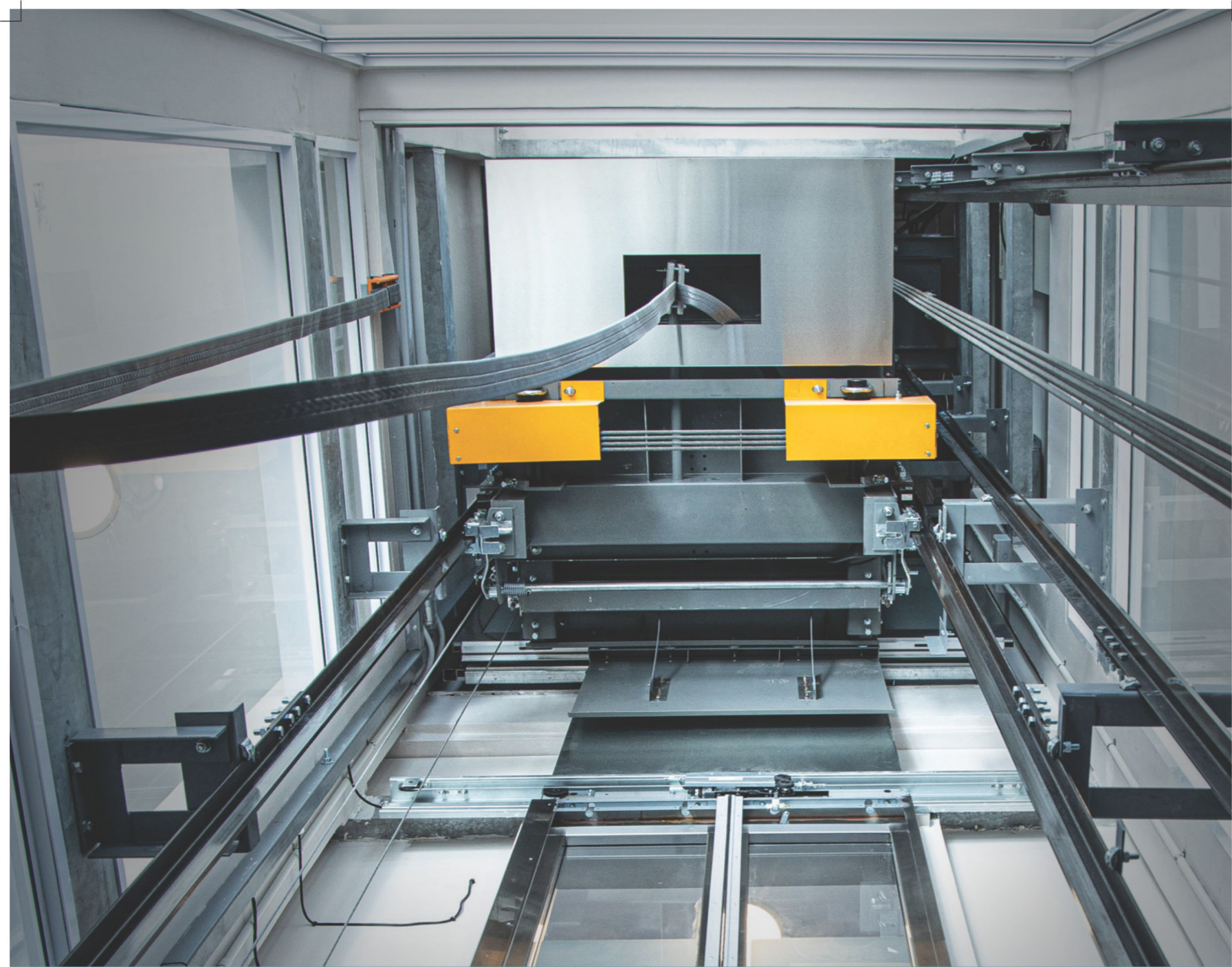

Guide Shoe ECGS-02

Capacity	up to 10 pax
Speed	up to 1.75 mps
Rail Size	9mm, 16mm

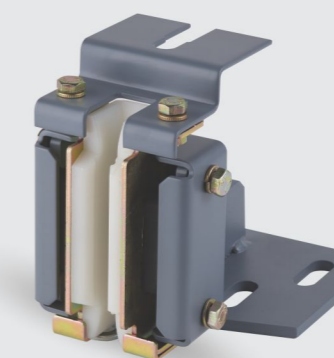

Guide Shoe ECGS-04

Capacity	13 to 20 pax
Speed	up to 1.75 mps
Rail Size	9mm, 16mm

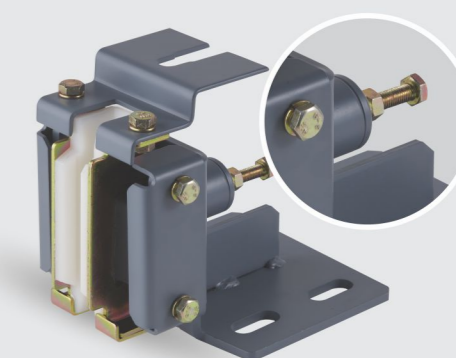

Guide Shoe ECGS-04ST

Capacity	13 to 20 pax
Speed	up to 1.75 mps
Rail Size	9mm, 16mm

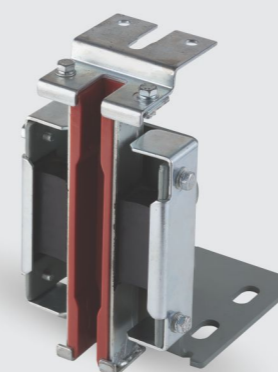

Guide Shoe ECGS-04HD

Capacity	20 Pax & Above
Speed	up to 1.75 mps
Rail Size	16mm

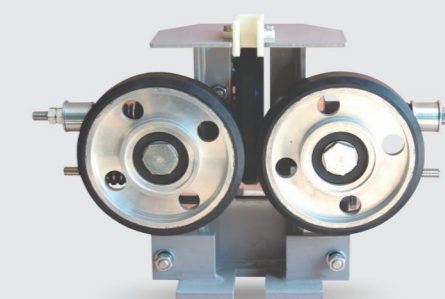

Guide Shoe ECGS-Roller

Speed	20 Pax & Above
Rail Size	16mm

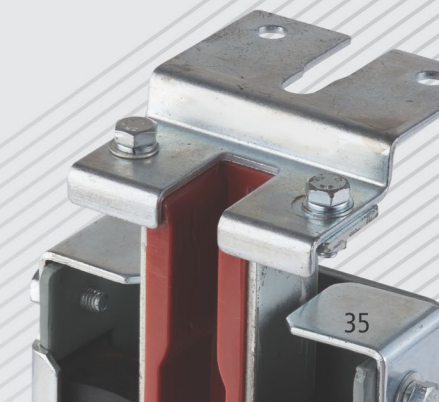

Our well-known European suppliers assure that all our complete products.

Projects Delivered



دبي هيلز إстейت دبي - دبي

Dubai Hills Estate, a master-planned community is a mixture of commercial and residential development which is located at the green heart of Dubai. A uniquely designed community set around the magnificent 18-hole championship golf course. This residential development is a unique development in itself that includes retail, leisure, and entertainment complex.

مركز الـ سي ريزيدنس

Mr. C Residences in Jumeirah, Dubai - the second luxury residential complex to arise from the fourth generation Cipriani family, following Mr. C Residences in Coconut Grove, Miami. Designed by the award-winning architecture firm Arquitectonica with interiors by Meyer Davis, and located in the heart of Jumeirah, boasting unparalleled views of the Burj Khalifa from the Dubai Canal.



نييرا دبي أتل هابتور سيتي

Neera, Dubai At Al Habtoor City Inside, you will find five elevated new dining concepts and a meeting space. Spanning 15,000 square feet over two floors, the lavish establishment is perfect for the city's social taste-makers, high-net-worth community, cultural connoisseurs and business leaders. Each establishment has been meticulously crafted by renowned chefs and award-winning teams to ensure only the best for members.



PROJECTS DELIVERED

Projects Delivered



Sharjah – Sustainable City

Sharjah Sustainable City is the first sustainable master planned community in the Emirate of Sharjah. Powered by renewable energy, the city aspires to achieve Net Zero Energy. It also treats 100% of its wastewater for landscape irrigation and maximizes recycling to divert waste from landfills. The city produces its own chemical-free leafy greens and vegetables and promotes walkability and the use of clean mobility.

Emirates Hills – Dubai

A world-class development, **Emirates Hills** is one of the most premier and sought-after gated communities in the city. Touted as the 'Beverly Hills of Dubai', it is an exclusive residential destination teeming with beautiful landscapes, panoramic views, state-of-the-art amenities, and 600 villas each with a luxurious character.



Jumeirah Park, Dubai, UAE

Elegant architecture, beautifully complimented with a lush green landscape enclosed in a gated community defines Dubai's Jumeirah Park. The modern residential community, housing around 3,000 independent luxury villas encompasses a great combination of modern amenities and infrastructure that reflect Dubai's happening lifestyle, yet manages to exude a sense of serenity, calmness and security – much needed for a family-friendly environment.



Projects Delivered



Al Zeina In Al Raha Island, Abu Dhabi







Al Zeina at Al Raha Beach project is in Abu Dhabi, designed by Esquisse Design Studio. Completed for Aldar Developments, the 1 km long waterfront incorporating a 300metre long sandy beach.



Yas Island- Abu Dhabi

Yas is a magnificent island located in Abu Dhabi. The island's development began in 2006 with the aim of creating an integrated community for leisure, shopping and entertainment



	DUBAI HILLS ESTATE			
	ALTA			
	DAMAC HILLS	